



Home Elevators





**Built for every day,
designed for any style.**



**Garaventa Lift has been moving people since 1928.
Our products have always stood the test of time.**

We began by building tramways in the Swiss Alps. Garaventa Lift has since become a global organization, representing reliability, safety, and innovation.

A Garaventa Home Elevator will quickly become part of everyday life. Choose from a variety of materials and finishes to fit any budget and style.



Simplify daily routines.

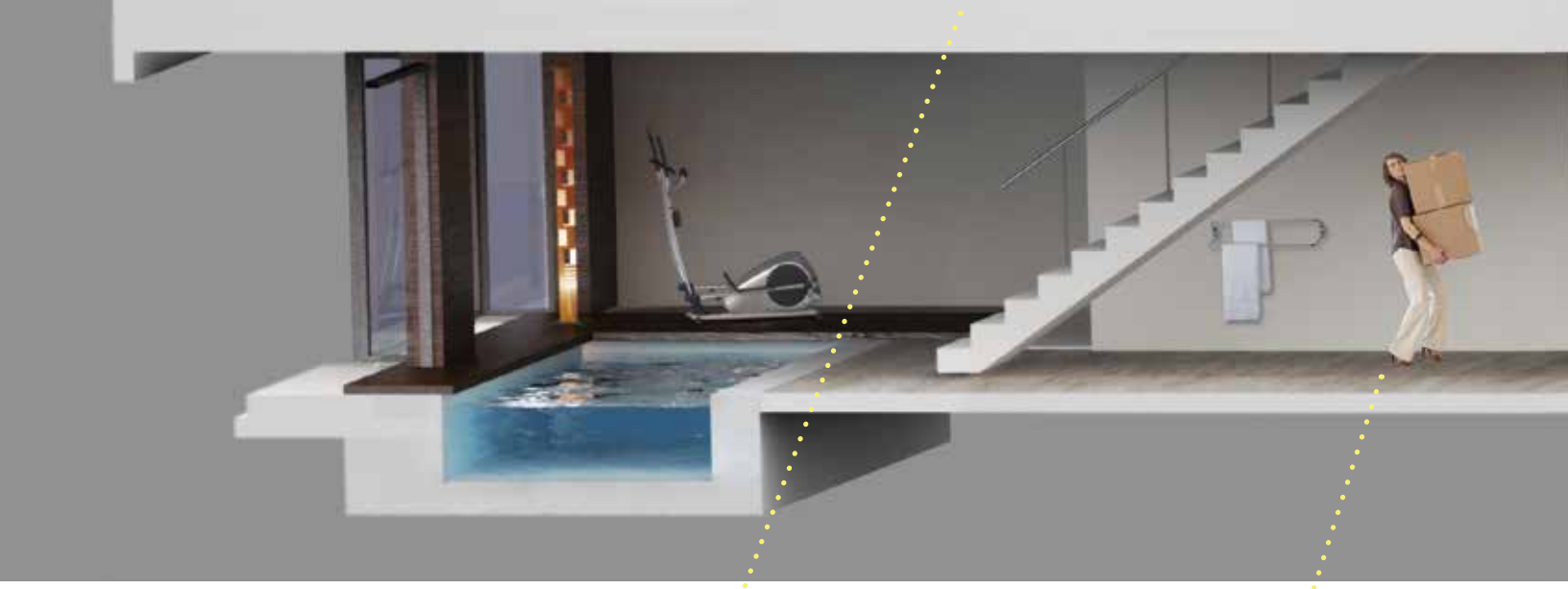

Daily routines made easier.

Reduce heavy lifting when transporting storage, laundry, or decorations.



Simplify multi-level entertaining.

Bring purchases home in one smooth trip.

Raised Panel

Raised panels in Oak, Maple, or Cherry give a traditional look to any application.

Available Finishes



Maple



Red Oak

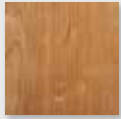

Cherry





Recessed Panel

Recessed center panels give a modern take to a traditional look. Offered in Oak, Maple or Cherry.

*Shown in Cherry wood.

Available Finishes



Maple

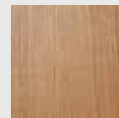

Red Oak

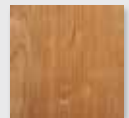

Cherry

Veneer Panel

Wood veneer offers a sleek wood option or a base for a cabinet finisher to add moldings to match any home decor.

Standard Veneers



Maple



Red Oak



Mahogany

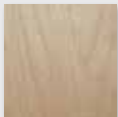

Birch

Optional Veneers

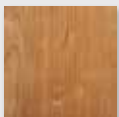

Cherry

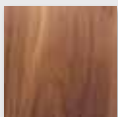

Walnut

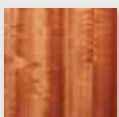

Makore

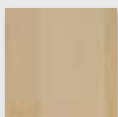

Bamboo

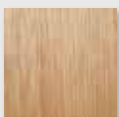

Hickory





Melamine Panel

Perfect for a durable, simple finish that is easy to maintain.

NOTE: Melamine walls are ONLY available in white or black when used with Upgrade or Premium sliding door packages

Available Finishes

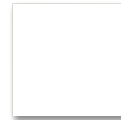

White



Antique White



Light Maple



Dark Maple



Gray

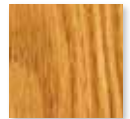

Oak



Walnut

Glass Panel

For a clean, modern, and open concept layout. Aluminum frames can be painted in white, black, or custom color.





Design It Yourself

Want an elevator, but undecided on the finishing? We provide the basics, and your builder finishes to your specifications.

WALL FINISHES

Wood Veneers

	Maple	Red Oak	Cherry	Mahogany	Birch	Walnut	Hickory	Makore	Bamboo
Raised Panel	*	*	*						
Recessed Panel	*	*	*						
Standard Veneer	*	*		*	*				
Optional Veneer			*			*	*	*	*

Melamine

	White	Antique White	Light Maple	Dark Maple	Gray	Oak	Walnut
Melamine Cab	*	*	*	*	*	*	*

NOTE: Melamine walls are ONLY available in white or black when used with Upgrade or Premium sliding door packages

Further Options

Glass Cab	Aluminum frame painted in white / black / custom paint
Design It Yourself	Medium Density Fiberboard (MDF) cab walls

STANDARD FIXTURES

Car Operating Panels



Includes a digital floor display, floor selection buttons and emergency stop/alarm button. Ensure passenger safety and security with an integral telephone. Finished in brushed stainless steel.

Hall Stations



Hall station buttons illuminate when pushed. The wall plates and push buttons are made of stainless steel for maximum durability. An optional key switch controls access.

Handrails



A handrail is located on the control wall. Additional handrails can be mounted for extra passenger safety.

Ceiling Lighting



Four recessed low-voltage L.E.D. light fixtures illuminate when the car gate is opened. Standard colors are white or black. Optional in chrome.

PREMIUM FIXTURES

Car Operating Panels



COP matches hall stations. Includes a digital floor display, floor selection buttons with a mirror finish backplate and emergency stop/alarm button. Only available with integral telephone. Four finishes available including brushed stainless steel, bright gold, midnight blue or antique black.

Hall Stations



Hall station buttons illuminate when pushed. The push buttons are made of stainless steel for maximum durability. Wall plates are offered in four finishes: brushed stainless steel, bright gold, midnight blue and antique black. An optional key switch controls access. A floor indicator display is also optional.

Handrails



A handrail is located on the control wall. Additional handrails can be mounted for extra passenger safety. Premium handrails are curved and return to the mounting wall, available in four finishes: stainless steel or brass, brushed or polished

Standard Package - swinging hall door with accordion car gate



Residential swinging passage doors are supplied by others as hall doors. During the installation of your elevator, the doors are fitted with special interlocks. They will open only when the elevator car is at the same landing. Solid core or solid wood core doors are required. The doors can be equipped with an optional automatic door operator.



With the standard door package, all cars are fitted with solid accordion gates. Standard manual operation or optional automatic power gate operation available.

Standard Gate Panels



Optional Gate Panels



Accordion gates are available with black, white, or antique white panels. Optional: bronze acrylic, clear acrylic, or perforated aluminum panels. Custom finishes available. All accordion gates are available with or without 3 clear acrylic vision panels located closest to the gate handle.

Upgrade Package - swinging hall door with sliding elevator car door

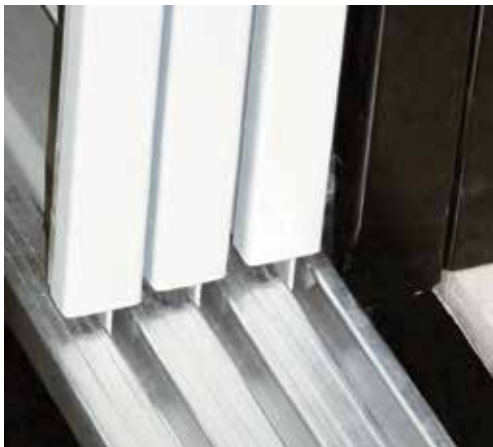

As with the Standard Door Package above, residential swinging passage doors are supplied by others as hall doors. During the installation of your elevator, the doors are fitted with special interlocks. They will open only when the elevator car is at the same landing. Solid core or solid wood core doors are required. The doors can be equipped with an optional automatic door operator.

With the upgrade door package, all car entrances are equipped with automatic 3-speed sliding elevator doors. The hallway landing doors are standard swinging passage doors supplied by others. The sliding car doors automatically open when the elevator reaches the destination landing, or when the elevator is summoned using the hall station. A safety light curtain ensures that there are no obstructions inside the door opening while the door is closing. If the light curtain senses an obstruction while the doors are closing, the doors will automatically re-open.

Sliding car doors are available with white, black or stainless steel panels.

DOORS AND GATES - HALL DOOR AND CAR DOOR COMBINATIONS

Premium Package - sliding elevator hall door and sliding elevator car door



The premium door package is the ultimate in safety and convenience. All car doors and hallway doors are automatic 3-speed sliding elevator doors. The hallway landing doors engage with the car doors as the elevator approaches each landing. Once the elevator has stopped at a landing, the automatic sliding elevator doors operate in tandem. A safety light curtain ensures that there are no obstructions inside the door opening while the door is closing. If the light curtain senses an obstruction while the doors are closing, the doors will automatically re-open. Sliding doors are available with primed steel, stainless steel or safety glass panels. The cab shown above has aluminum framing and safety glass wall panels. The wall with the control panel has safety mirror panels instead of glass.

DESIGN COMPLETION

Flooring



Design Assistance



www.garaventlift.com



Design Hotline: 1.800.663.6556 Toll Free North America

The Garaventa Home Elevator is designed to allow for installation of flooring by others to match your home decor. The flooring can be from 1/8" to 3/4" thick.

Hydraulic Drive

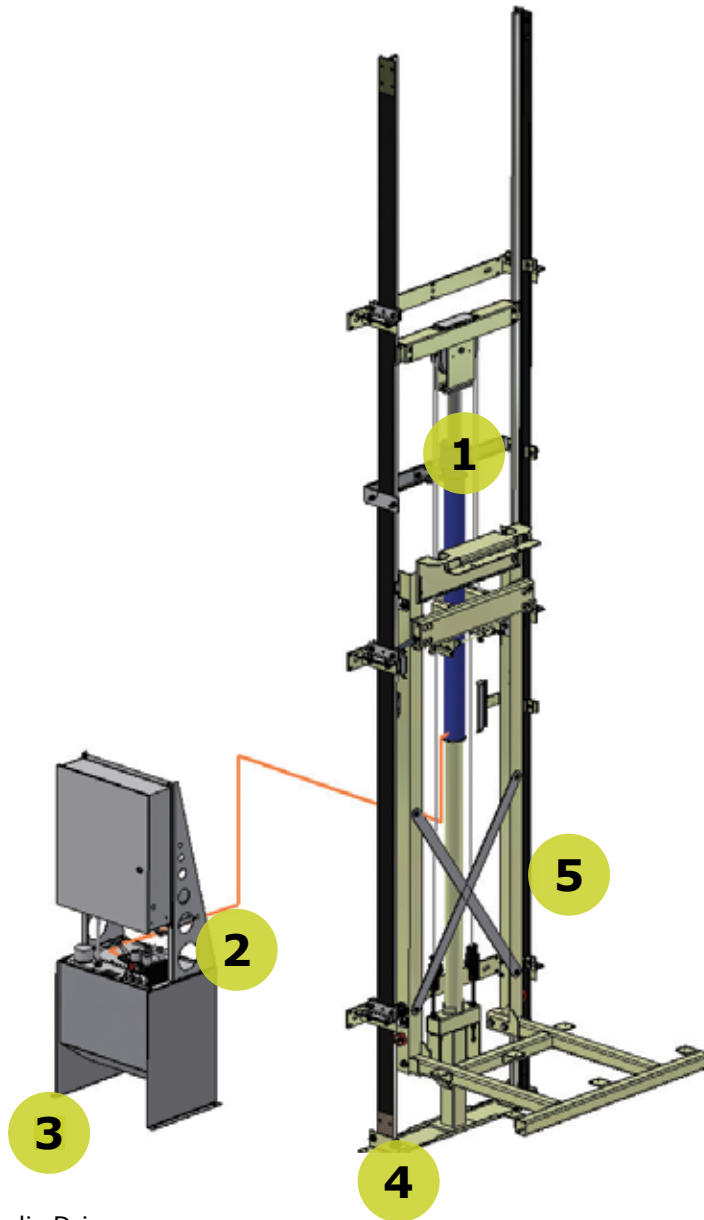

1 1:2 Cable Hydraulic Drive

2 Two-speed hydraulic control valve provides smooth, comfortable starting and stopping.

3 Submersed hydraulic pump and motor ensures quiet operation.

4 Recommended pit depth: 8" (203 mm). Shallower depths may be feasible. Deeper pits may be required for larger cab sizes.

5 System utilizes a heavy duty car sling which provides uncompromised stability.

In-Line Drive



- 1** Controller box and UPS (battery back up) can be mounted in a remote location up to 50 ft. (15.2 m) away. These components can also be mounted in the hoistway where permitted by code - **no machine room required!**
- 2** Direct drive electric motor located on top of the rail system

- 3** Counterweight frame connected to sling with dual chains. Exclusive chain dampening system allows for exceptionally smooth, quiet ride.
- 4** Recommended pit depth: 8" (203 mm). Shallower depths may be feasible.
- 5** System utilizes a heavy duty car sling which provides uncompromised stability.

HOISTWAY DIMENSIONS

Standard Door Package - swinging hall door with accordion car gate

Style 1					
Clear Cab Size	Hoistway Width	Hoistway Length	Jack Centerline	Entrance Centerline	
36 x 48	51	56 1/4	30	30 1/4	
36 x 54	51	62 1/4	33	30 1/4	
36 x 60	51	68 1/4	36	30 1/4	
40 x 54	55	62 1/4	33	34 1/4	
42 x 60	57	70 1/4	36 5/8	36 1/4	
48 x 60	63	70 1/4	36 5/8	42 1/4	
Style 2					
Clear Cab Size	Hoistway Width	Hoistway Length	Jack Centerline	Entrance Centerline	
36 x 48	51	54 3/4	27 3/8	30 1/4	
36 x 54	51	60 3/4	30 3/8	30 1/4	
36 x 60	51	66 3/4	33 3/8	30 1/4	
40 x 54	55	60 3/4	30 3/8	34 1/4	
42 x 60	57	73 1/2	36 3/4	36 1/4	
48 x 60	63	73 1/2	36 3/4	42 1/4	
Style 3 & 4					
Clear Cab Size	Hoistway Width	Hoistway Length	Jack Centerline	Entrance A Centerline	Entrance B Centerline
36 x 48	54 7/8	56 1/4	30	30 1/4	34 3/4
36 x 54	54 7/8	62 1/4	33	30 1/4	40 3/4
36 x 60	54 7/8	68 1/4	36	30 1/4	46 3/4
40 x 54	58 7/8	62 1/4	33	34 1/4	40 3/4
42 x 60	60 7/8	70 1/4	36 5/8	36 1/4	48 3/4
48 x 60	66 7/8	70 1/4	36 5/8	42 1/4	48 3/4
Style 5					
Clear Cab Size	Hoistway Width	Hoistway Length	Jack Centerline	Entrance Centerline	
36 x 48	54 7/8	54 1/4	27 1/8	27 1/8	
36 x 54	54 7/8	60 1/4	30 1/8	30 1/8	
36 x 60	54 7/8	66 1/4	33 1/8	33 1/8	
40 x 54	58 7/8	60 1/4	30 1/8	30 1/8	
42 x 60	60 7/8	66 1/4	33 1/8	33 1/8	
48 x 60	66 7/8	66 1/4	33 1/8	33 1/8	

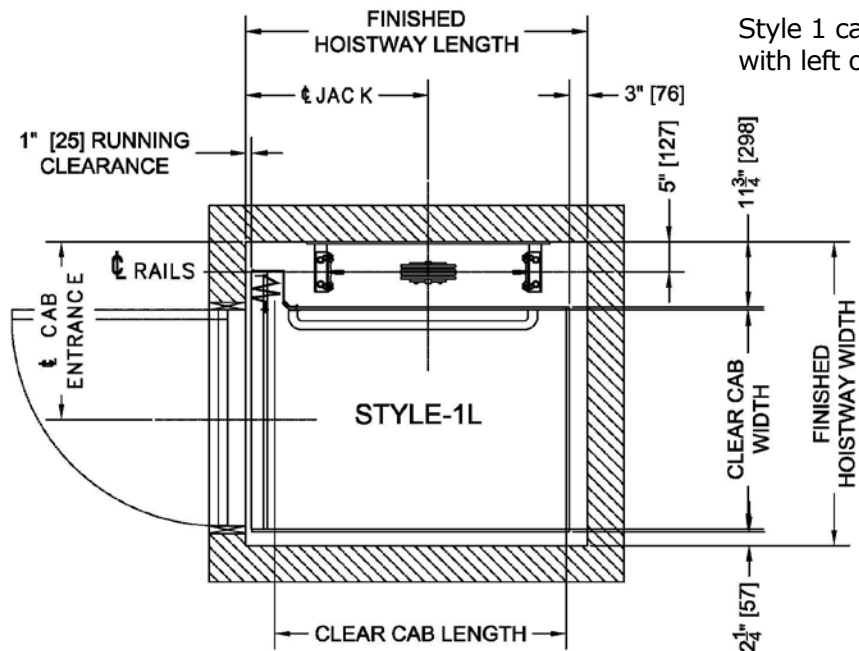

HOISTWAY DIMENSIONS

Standard Door Package - swinging hall door with accordion car gate

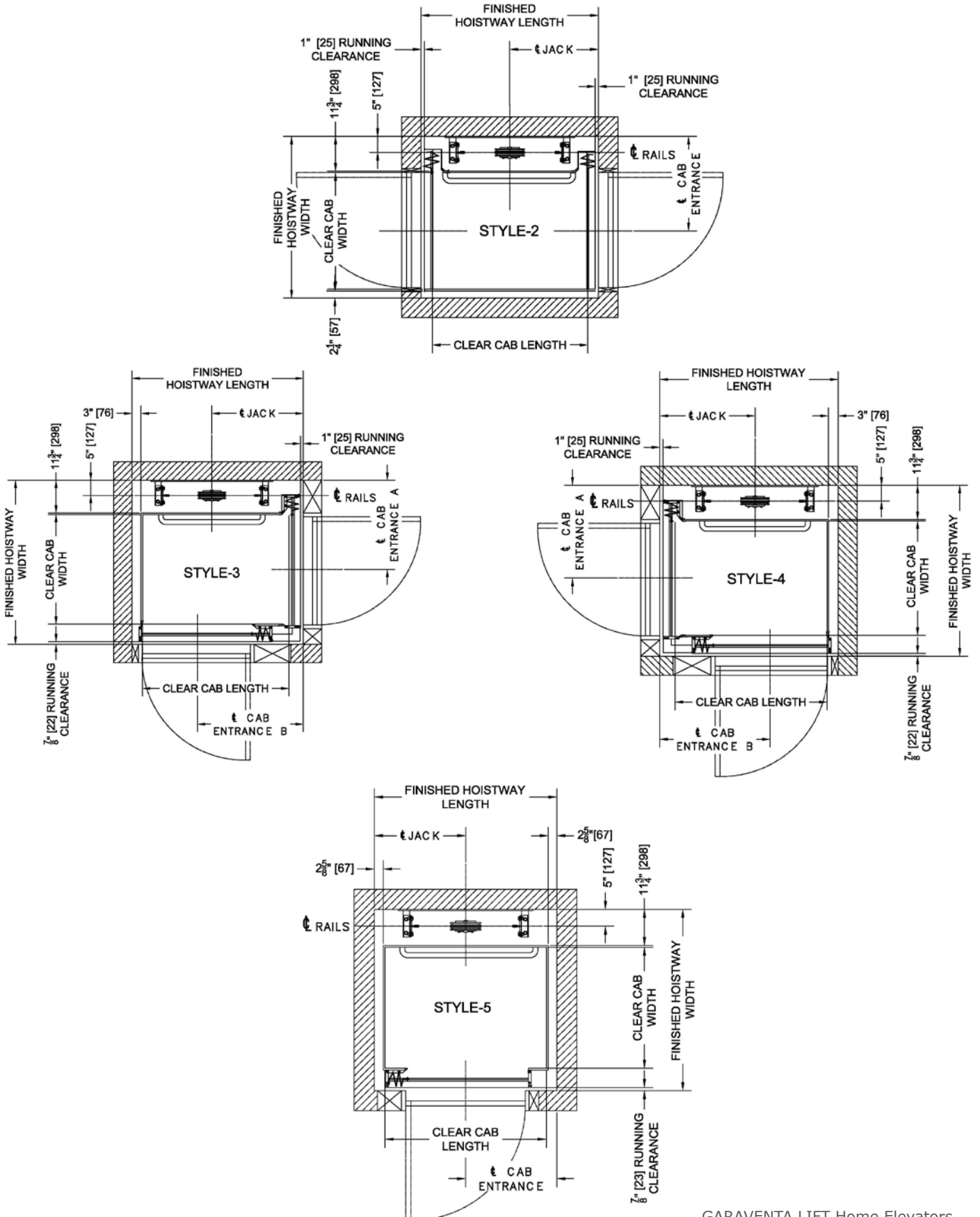

HOISTWAY DIMENSIONS

Upgrade Door Package - swinging hall door with sliding elevator car door

Style 1					
Clear Cab Size	Hoistway Width	Hoistway Length	Jack Centerline	Entrance Centerline	
40 x 50	57 1/4	62 3/4	33	33 1/2	
40 x 54	57 1/4	66 3/4	35	33 1/2	
42 x 60	59 1/4	72 3/4	38	35 1/2	
48 x 60	65 1/4	72 3/4	38	41 1/2	
Style 2					
Clear Cab Size	Hoistway Width	Hoistway Length	Jack Centerline	Entrance Centerline	
40 x 50	57 1/4	66	33	33 1/2	
40 x 54	57 1/4	70	35	33 1/2	
42 x 60	59 1/4	76	38	35 1/2	
48 x 60	65 1/4	76	38	41 1/2	
Style 3 & 4					
Clear Cab Size	Hoistway Width	Hoistway Length	Jack Centerline	Entrance A Centerline	Entrance B Centerline
40 x 50	60 1/2	62 3/4	33	33 1/2	39
40 x 54	60 1/2	66 3/4	35	33 1/2	43
42 x 60	62 1/2	72 3/4	38	35 1/2	49
48 x 60	68 1/2	72 3/4	38	41 1/2	49
Style 5					
Clear Cab Size	Hoistway Width	Hoistway Length	Jack Centerline	Entrance Centerline	
40 x 50	60 1/2	59 1/2	29 3/4	35 3/4	
40 x 54	60 1/2	63 1/2	31 3/4	39 3/4	
42 x 60	62 1/2	69 1/2	34 3/4	45 3/4	
48 x 60	68 1/2	69 1/2	34 3/4	45 3/4	

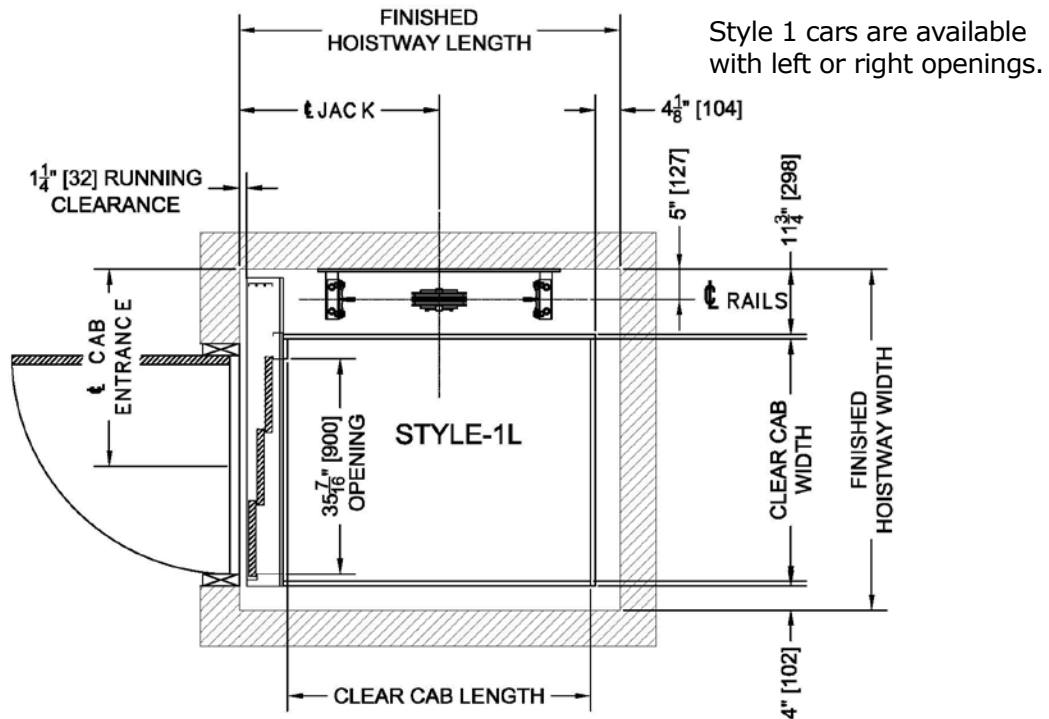

Upgrade Door Package - swinging hall door with sliding elevator car door

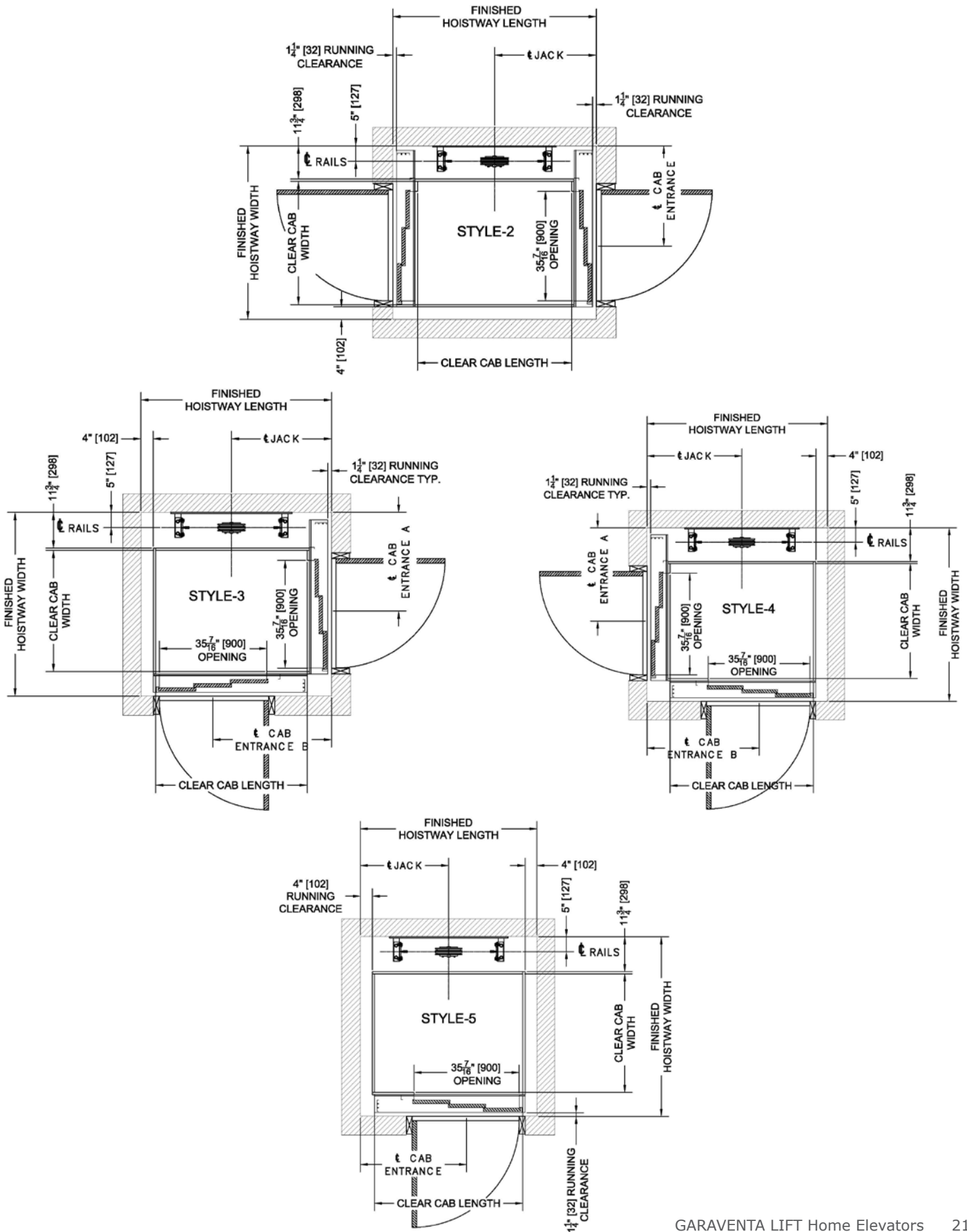

HOISTWAY DIMENSIONS

Premium Door Package - sliding elevator hall door with tandem sliding elevator car door

Standard mounting method - as shown

Style 1					
Clear Cab Size	Hoistway Width	Hoistway Length	Jack Centerline	Entrance Centerline	
40 x 50	57 1/4	68 1/4	38 1/2	33 1/2	
40 x 54	57 1/4	72 1/4	40 1/2	33 1/2	
42 x 60	59 1/4	78 1/4	43 1/2	35 1/2	
48 x 60	65 1/4	78 1/4	43 1/2	41 1/2	
Style 2					
Clear Cab Size	Hoistway Width	Hoistway Length	Jack Centerline	Entrance Centerline	
40 x 50	57 1/4	77	38 1/2	33 1/2	
40 x 54	57 1/4	81	40 1/2	33 1/2	
42 x 60	59 1/4	87	43 1/2	35 1/2	
48 x 60	65 1/4	87	43 1/2	41 1/2	
Style 3 & 4					
Clear Cab Size	Hoistway Width	Hoistway Length	Jack Centerline	Entrance A Centerline	Entrance B Centerline
40 x 50	66	68 1/4	38 1/2	33 1/2	44 1/2
40 x 54	66	72 1/4	40 1/2	33 1/2	48 1/2
42 x 60	68	78 1/4	43 1/2	35 1/2	54 1/2
48 x 60	74	78 1/4	43 1/2	41 1/2	54 1/2
Style 5					
Clear Cab Size	Hoistway Width	Hoistway Length	Jack Centerline	Entrance Centerline	
40 x 50	66	59 1/2	29 3/4	35 3/4	
40 x 54	66	63 1/2	31 3/4	39 3/4	
42 x 60	68	69 1/2	34 3/4	45 3/4	
48 x 60	74	69 1/2	34 3/4	45 3/4	

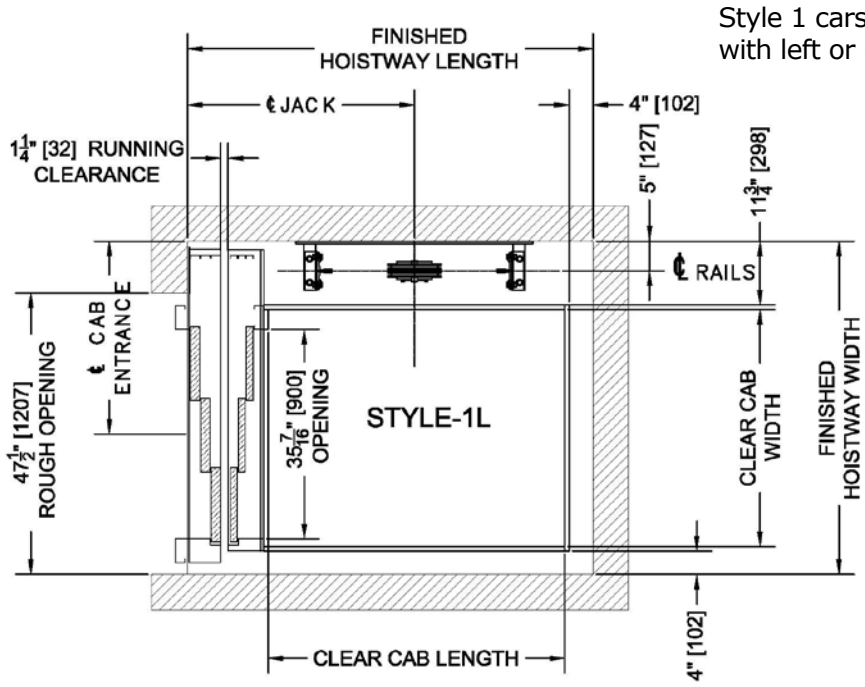

Style 1 cars are available with left or right openings.

Premium Door Package - sliding elevator hall door with tandem sliding elevator car door

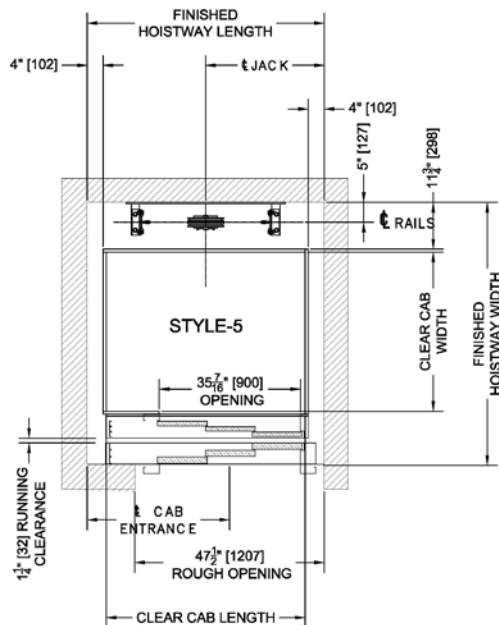
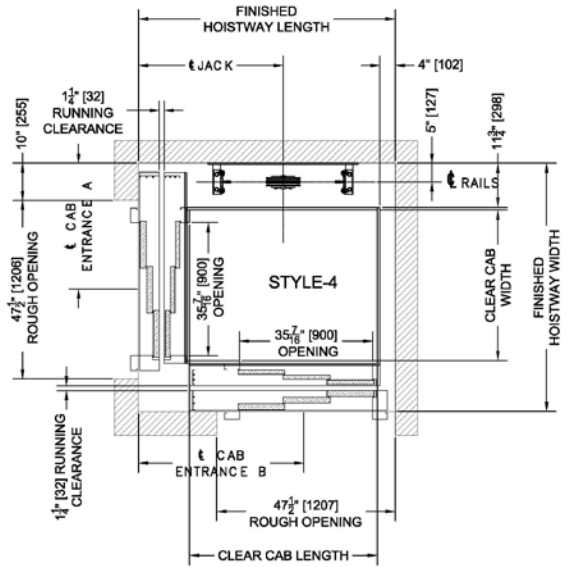
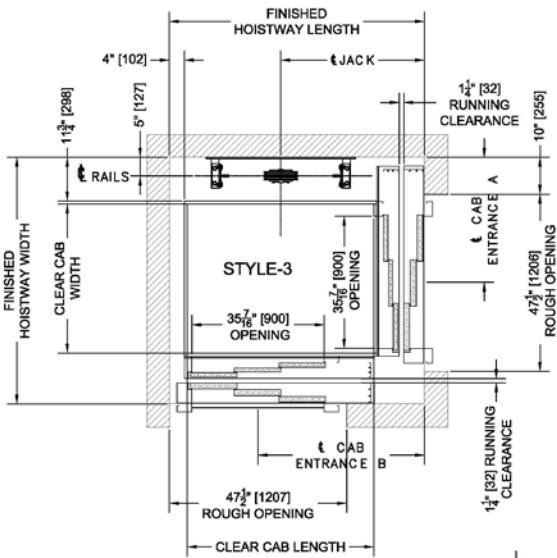
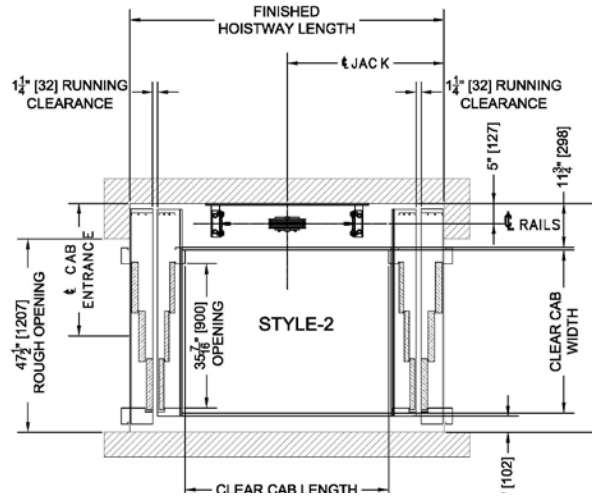

SPECIFICATIONS

Overhead Clearances Required:

	Hydraulic Drive	In-Line Drive w/ Controller outside Hoistway	In-Line Drive w/ Controller at top of Hoistway
84" Cab Height			
Standard Door Package	96" (2438 mm)	96" (2438 mm)	108" (2743 mm)
Upgrade or Premium Door Package	96" (2438 mm)	96" (2438 mm)	114" (2896 mm)
96" Cab Height			
Standard Door Package	108" (2743 mm)	108" (2743 mm)	120" (3048 mm)
Upgrade or Premium Door Package	N/A	N/A	N/A

Rated Load: Standard 750 lbs (340 kg) or 1,000 lbs (455 kg)

Speed: 40 ft/min (12.2 meters/min) nominal speed

Travel Range: Up to 50 feet (15.2 m)

Stops: Up to 6 stops

Standard Controls: Fully automatic push button operation | Digital floor indicator in car | Automatic car lighting upon entry | Illuminated push buttons

Standard Safety Features: Battery-powered emergency lowering | Safety brake system | Car door and hall door safety monitoring system | Emergency stop and alarm

Hydraulic Drive System: 1:2 cable hydraulic drive | Quiet submersed pump and motor | Two-speed valve for smooth start and stop

In-Line Drive System: Geared direct drive motor | Variable frequency drive for smooth start and stop

Power Requirements: 230 VAC single phase | Optional 208 VAC 3 phase (Hydraulic Drive only)

Popular Options: Premium fixtures | Integral emergency telephone | 3-speed sliding doors

Warranty: 2 year standard warranty | Optional additional 5 year extended warranty to 7 years (North America Only)



**Home
Elevators**

**(800) 663-6556
www.garaventalift.com**

© Garaventa Lift. As we are continuously improving our products, specifications outlined in this brochure are subject to change without notice. Due to the nature of the printing process, colors shown in the brochure may not be an accurate representation of the actual product.

37156-S-PB

